

MICHAEL ANASTASSIADES

Tube Chandelier, 2006





Tube Chandelier, 2006

Satin brass or black patinated stainless steel

Pendant rod length to order

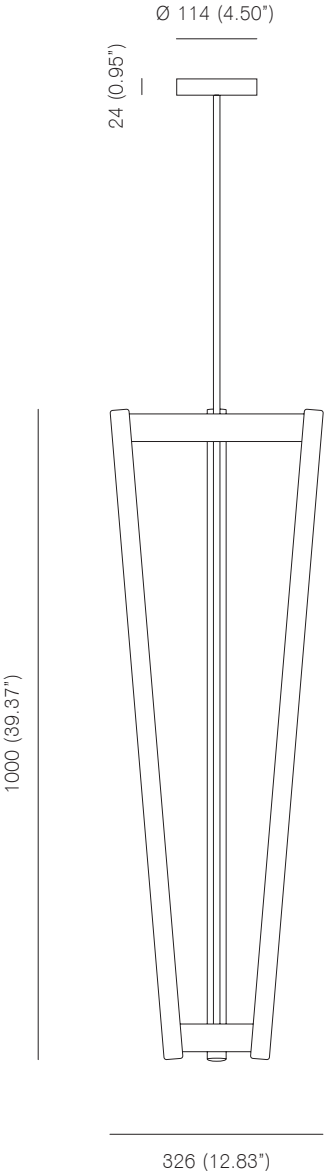

Bulb Specifications

Bulb specifications 120 / 240V

S14s opal LED tube
Radium Raledina 16,5W / 1000mm ø29mm
1000 lm / 2700K

Product Specifications

Input voltage: 120V / 240V
Maximum wattage: 16,5W
Dimmable: yes
Product weight: ~6kg

Pendant rod length to order.
Minimum total drop length 1500mm. Maximum total drop length 2980mm
Please supply required drop length of fixture, measured from the ceiling to bottom of fitting at time of order.
Please allow 25mm tolerance of drop length.

Cleaning Instructions

Before cleaning, lighting fixtures must be turned off and unplugged from mains electricity. Whilst cleaning them please be extremely careful and use the white cotton gloves provided in the product box.

Satin brass: As the item is unlacquered, it naturally oxidises (darkens). Upon touching the items without gloves, finger prints are likely to occur and leave marks. Use the Scotch Brite pad (supplied in the product box) and gently rub the pad in the direction of the grain. Repeat until the natural patina is removed. On rubbing the Scotch Brite to the brass, dust will occur. The colour of the product will temporarily get lighter until it re-oxidises.

Black patinated: The black patinated Tube Chandelier is copper plated before being patinated in black. This fabrication process allows the copper to shine through, making it just visible around the edges of the item. Use a lightly damp soft dust cloth and gently go over marks until clean. Dry it afterwards with a soft dust cloth. Make sure the product is completely dry before switching the electricity on.

Glass tube: Remove the bulb from the product. Using a lightly damp cloth, clean only the outside of the sphere and dry it with a dry soft dust cloth. Only put the glass bulb back on the product once it is fully dry.

Backplate

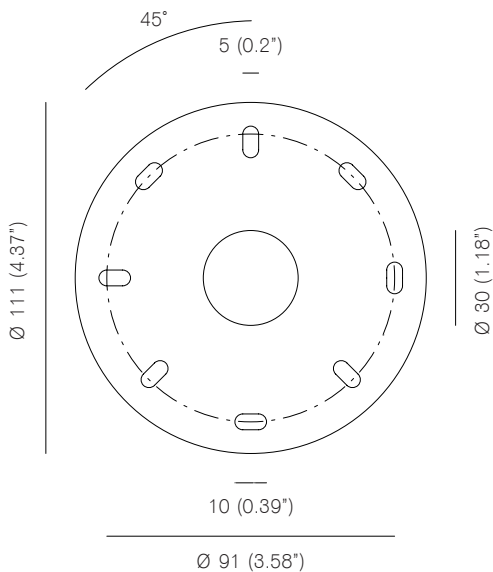

Mounting screws not included.
5mm countersunk screw recommended.

Michael Anastassiades' design philosophy is to preserve the inherent qualities of given material. All of our products are handmade and come in natural finishes, exposed to the elements without any protective lacquers. We look at oxidisation as part of a process that adds to the patina of an object, increasing beauty with time. We try our best for all goods to leave our premises in pristine condition, but sometimes products may arrive with minor oxidisation marks.

Whilst every effort is made to ensure accurate representation of product colours, finishes and dimensions, Michael Anastassiades Ltd reserves the right to alter these details without notice, in compliance with its own production needs, technological changes or in response to the current market needs. Colour swatches are for reference only; Michael Anastassiades Ltd cannot guarantee exact colour match for any product finishes.

All designs are protected under copyright law. Michael Anastassiades holds the exclusive manufacturing and distribution rights worldwide. Copying will be prosecuted.

All light fixtures in this catalogue have CE marking compliance.

Michael Anastassiades Ltd.
50 Rochester Pl, London NW1 9JX, UK
T +44 (0)20 7928 7527
sales@michaelanastassiades.com
www.michaelanastassiades.com
© 2019 Michael Anastassiades Ltd. All rights reserved.